

1 Register For TetraCare™ - Free Online And Toll-Free Assistance

Before you set up your aquarium, log on to www.tetra-fish.com and register for TetraCare™. You'll receive complete set-up information, including animated instructions for setting up your aquarium. Plus a series of e-Minders (fish care e-mails) to guide you through maintenance activities for the first six months to help you create a healthy environment for beautiful fish. You'll also have access to answers to all of your questions from:

- 1) The website (www.tetra-fish.com)
- 2) E-mail (always answered within 24 hours)
- 3) Live telephone support at 800-423-4658

Best of all, TetraCare™ is FREE!



2

Rinse Equipment & Decor

Rinse the aquarium, heater and decorations. Use plain tap water. NEVER use soap or other cleaners inside the aquarium, as cleaning agents leave a residue that will harm your fish.

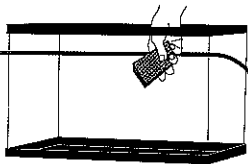
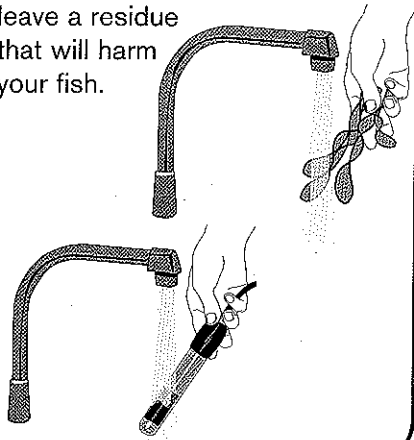

3

Position Your Aquarium

For the best results, use an approved aquarium stand which was designed to support the weight. The filled weight of an aquarium is approximately 10-12 lbs per gallon (example: a 20 gallon aquarium filled with water and gravel can weigh over 200 lbs). Never set up your aquarium on shelving, bookcases, dressers, carts or any place that will not support the weight of a full aquarium.

Tip: Do not place your aquarium where it will receive direct sunlight as this can cause excessive algae growth. Avoid placing your aquarium in front of a heating register as this can cause temperature fluctuations.

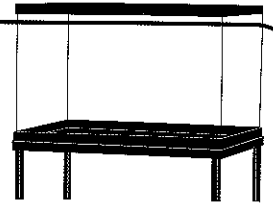

4

Rinse and Add Gravel

Be sure you have enough gravel for at least a 1" depth. A simple rule of thumb is 1 to 2 lbs of gravel per gallon of water. Larger tanks may require more. To rinse gravel, use a clean, 5-gallon bucket that will be used ONLY for your aquarium. Put gravel in bucket and fill with cold (never warm or hot) water. Swirl gravel with your hand to remove dust and then pour out water; repeat until water is clear. Pour the rinsed gravel into the aquarium. Slope the gravel, lower in the front and higher in the back of the tank.

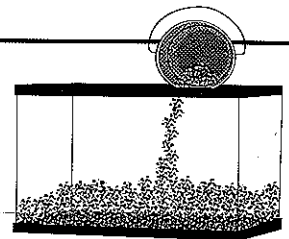

5

Fill Aquarium 1/3 Of The Way With Water

Now your tank is ready for water. But you won't be filling it all the way just yet! Fill your aquarium about 1/3 full with water.

Tip: Pour the water onto a small rinsed plate, to avoid disturbing the gravel.

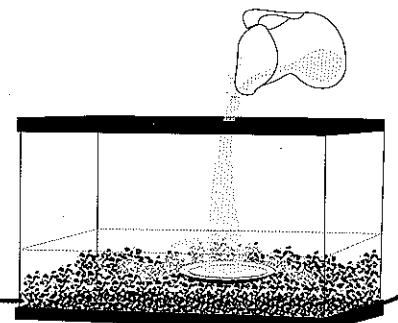

6

Decorate Aquarium, Fill with Water

Arrange your rinsed plants and other decorations. You can use live plants or plastic plants, such as Tetra Plantastics®. You can also add rocks or driftwood to give the tank a natural appearance.

Tip: Be sure to only use plants, rocks and driftwood sold specifically for aquariums; DO NOT USE sea shells or coral in freshwater tanks, except for specific fish that live in water with high pH, such as African Cichlids.

Fill the tank with tap water, until the water is even with the bottom of the rim around the top of the aquarium. Treat the water with the enclosed Tetra AquaSafe® (1 tsp per 10 gallons) to remove harmful chemicals like chlorine, ammonia and chloramines.

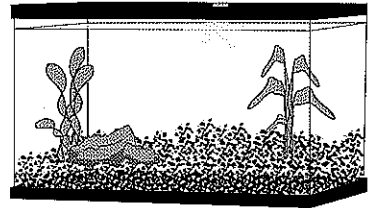
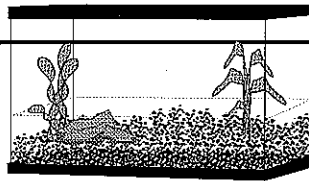

7

Install Filter

A. Unpack filter from bag – you should have: Filter cover (#1) and Filter box (#2).

The Filter box will have the Energizer motor attached. Check to see if the Energizer (#3) is attached securely.

B. Take Bio-Bag® out of the package and rinse Bio-Bag® under cold water. Place Bio-Bag® in filter box as pictured (#4).

C. Remove Wonder Tube® Assembly (#5) from package. The Wonder Tube® Assembly contains 3 parts: the Magnet Impeller Assembly (#6), the Main Tube (#7), and the strainer (#8). Be sure all 3 parts are securely attached. Refer to illustration.

D. Place assembled filter on back of aquarium (#10). Pour water into Wonder Tube® Chamber (#9) (the area in the filter box above the Energizer Motor).

E. Plug in filter. Allow the filter to run for a few minutes to self-prime. Double check filter for possible leaks resulting from improper installation.

Refer to detailed manufacturer's instructions for further installation and maintenance information.

Tip: Add a drip loop on all power cords (#11).

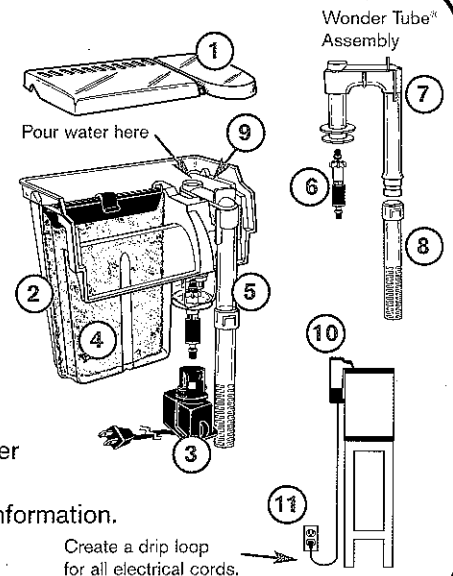

8

Install Heater and Thermometer

If you are planning to have goldfish in your aquarium, you will not need a heater.

If you are planning to have tropical fish, install and operate the heater according to the manufacturer's instructions included with the heater. Be sure to place the heater near the outflow of the filter so that heated water will circulate throughout the tank. Important: Let heater adjust to water temperature for 20 minutes before plugging in. Never operate the heater out of the water.

Place your thermometer on the bottom front or side of the tank, at the opposite end of the tank from the heater.

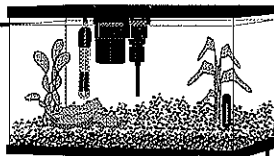

9

Install Hood and Light

Install the hood and light according to the instructions provided in this kit. Be sure to remove the knockout panels for a proper fit around the Power Filter and Heater.

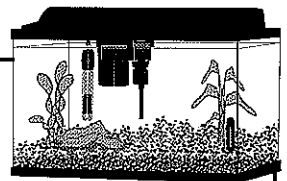

10

Allow the Aquarium to Stabilize

Allow the filter and heater to run for 24 to 48 hours to be sure the equipment is operating properly, and the temperature has stabilized around 76-80° F (for Tropical Fish Tanks). Do not add fish until after this period. Some water cloudiness may occur the first few days after set-up but will soon clear. When you're ready to add fish, talk to the Aquatic Specialists at your local PETCO. They can recommend the best fish for your aquarium. And be sure to log on to www.tetra-fish.com for information on how to select and add fish to your aquarium.

